

Accident Prevention Program

On Landings, Part I

Being a safe pilot means combining your working knowledge of aviation with current skills and experience -tempered by good judgment.

One important phase of flying skill is the landing. Landing phase accidents are responsible for nearly half of all general aviation accidents. By fortifying your knowledge of the "whys" and "wherefores" of approach and landing accidents, you can become a safer pilot.

In this handout we'll look at undershooting and cross-control stalls-the kinds of accidents which can happen *before* you reach the runway. Also, we'll look at hard landings, porpoising, and loss of directional control-problems encountered *after* reaching the runway.

THE UNDERSHOOT

At one time or another every one of us has miscalculated an approach and started to undershoot the runway. It's hard to forget that "sinking" feeling you had when you first realized that the airplane might not make the runway.

Poor pattern techniques such as flying too wide a pattern on downwind, or making a late turn to base leg are frequent causes of undershooting.

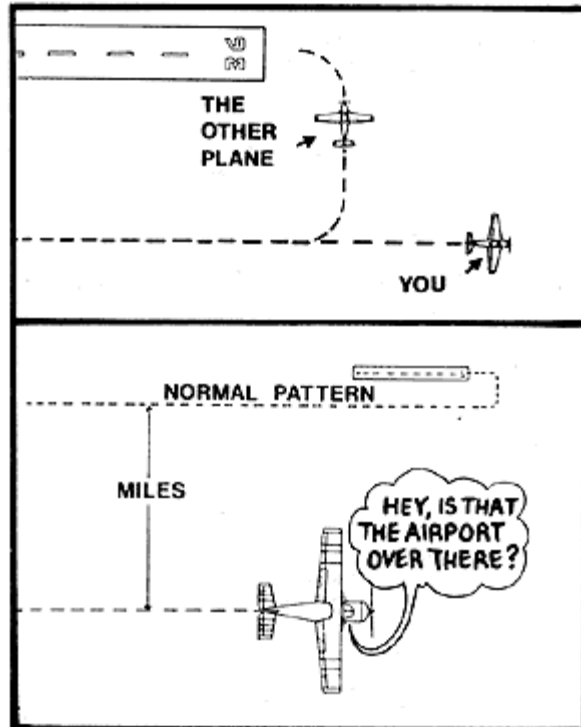

Another cause is failure to maintain adequate power on final.

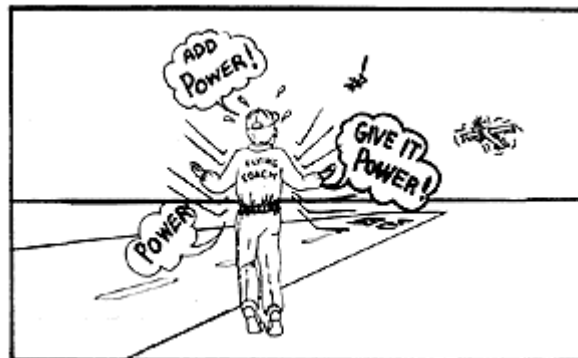

Some pilots succumb to "runway fixation" and unconsciously try to "carry" the airplane up to the landing spot by easing the nose up without adding power-this doesn't work very well.

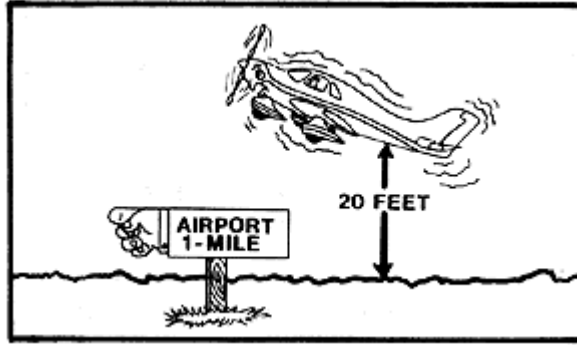

You can help set up a proper and constant distance from the runway for all airports by placing the runway centerline at a specific point on the leading edge of the wing (low wing airplane) or a point along the strut (high wing airplane). You may even put a mark or piece of tape at the proper wing strut position.

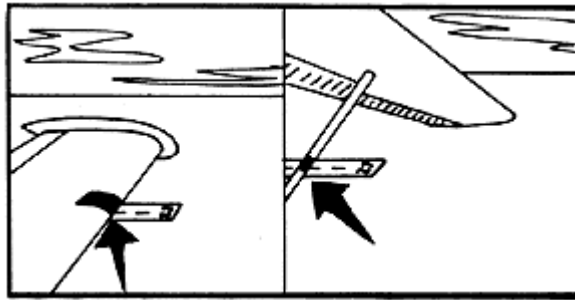

Using the runway centerline as your guide takes care of wide or narrow runways. (Of course, this reference line or point only works when the wings are level.)

Avoiding Undershoots

How do you avoid undershoots? A good pattern helps.

When traffic isn't a factor, turn base when the point of intended touchdown is 45 degrees behind the wing.

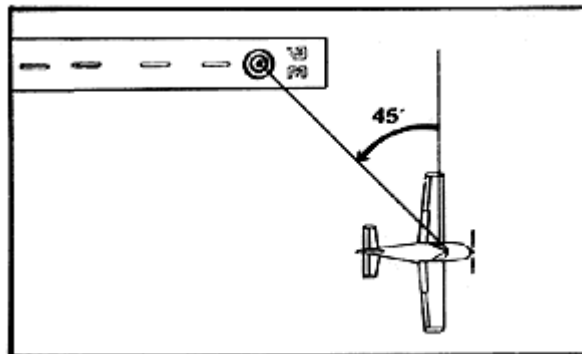

At a familiar airport, you may be able to use the "crutch" of familiar landmarks to determine proper turning points. But at unfamiliar airports you won't have such "hometown" references.

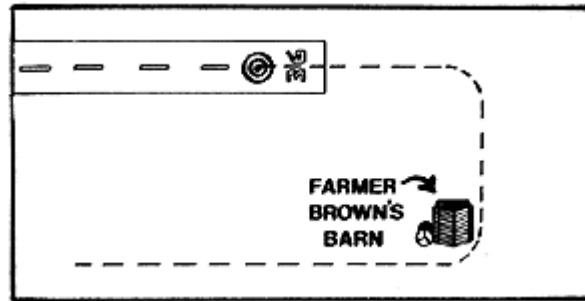

The 45 degree technique will work at any airport.

When there is other traffic in the pattern, you can avoid the common problem of the "ever-lengthening downwind" by starting your turn to base just after the airplane you're following turns final and passes behind your wing (assuming that it's not using a much slower approach speed than yours).

Experienced pilots often use a series of imaginary windows on approach. These "reference points in the sky" are great aids in determining whether your approach is within the desired horizontal and vertical limits.

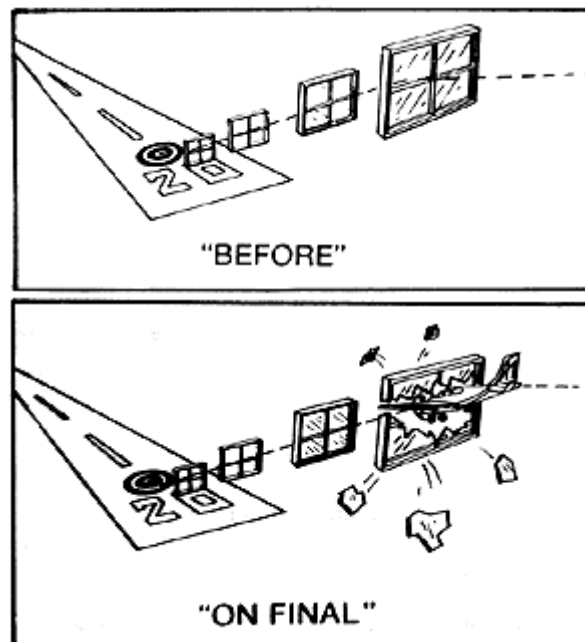

The first window should be encountered just after turning final.

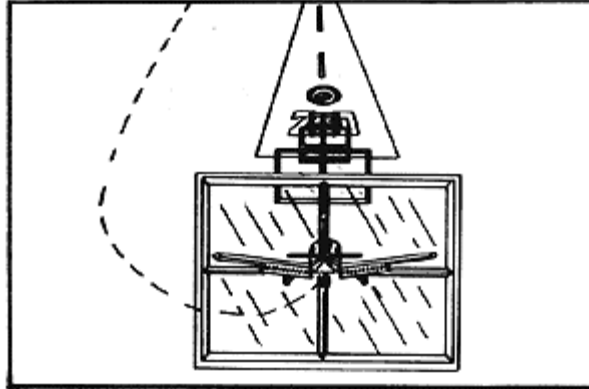

If there are obstacles between your imaginary window and the runway, either raise the "windows" or move them.

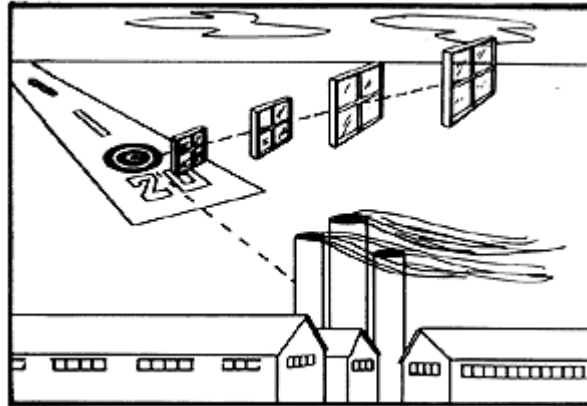

Your last and most important window is the one at the runway threshold. You should be at the required airspeed and height to complete the landing when you pass through this last window.

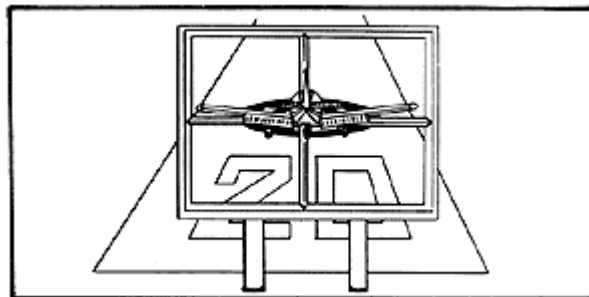

Flying the Right Airspeed

Pilots of large aircraft always determine what their approach speeds will be in advance. They calculate the aircraft's landing weight, then look at charts for the right "reference speed." or V-ref. The keystone V-ref, although different on almost every approach, is based on the airplane's stall speed and other factors at its estimated landing weight.

Added to V-ref by the pilot is additional airspeed required to maintain an adequate safety margin while maneuvering in the pattern as well as additional airspeed to compensate for wind gusts, turbulence and wind shear.

"Approach segment airspeeds," based on V-ref, assure that the aircraft has just the right amount of extra airspeed margin above V-ref.

Smaller aircraft do not come with V-ref tables. Some manufacturers, however, furnish recommended approach speeds corresponding to different aircraft weights.

Such tables can be developed and it is suggested that you prepare and use your own. We recommend that you use the format in the following table, but before you fill it in, we suggest that you see Part II of "On Landings", and read the accompanying handout for Part II carefully.

V-SPEEDS

Landing Weight	_____
	<u>Knots-IAS</u>
PRE-PATTERN	_____
DOWNWIND	_____
BASE	_____
FINAL	_____
SHORT FINAL	_____

There are rules-of-thumb, however:

1. On downwind, fly no faster than the "top of the flap operating range" and no slower than 1.4 times the calibrated stall speed for your airplane at its *actual* landing weight, or 1.4 V_{so}. (There are exceptions, so please read Part II.)
2. Maintain an airspeed no lower than 1.4 V_{so} until after turning final.
3. Then, on final, let your airspeed decay to 1.3 V_{so} as you near the runway.
4. If you encounter any turbulence, wind gusts or wind shear, compensate with additional airspeed on each segment of the approach.

The Stabilized VFR Approach

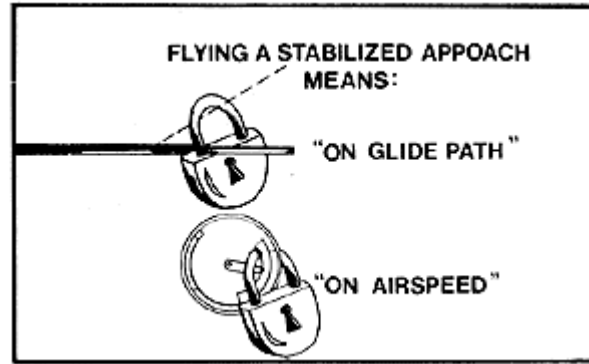

Make your normal pattern entry and extend your landing gear on downwind, if applicable. Abeam the intended landing point, reduce your power to the predetermined value that works best for your airplane. While holding altitude with pitch, slow the airplane down in preparation for turning base.

Then set partial flaps, if you haven't already done so. If you have reduced power properly, you can now trim the aircraft and set up a descent.

Begin your turn to base when the point of touchdown is 45 degrees behind the wing. Turn base, then final, keeping all banks to 30 degrees or less.

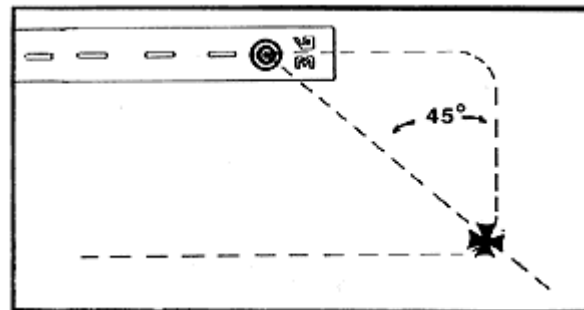

Should you need to increase your rate-of-descent, do so either by reducing power or by further extending flaps to increase drag. If you do extend flaps, remember that you've just modified your approach configuration and that adding power may be necessary to stay on the selected glide path at your targeted speed.

A fundamental key to flying a stabilized approach is the inter-relationship of *pitch* and *power*.

At any targeted airspeed in any configuration, adding more power will make the glide path shallower; reducing power will make it steeper.



This inter-relationship means that any changes to one element in the "approach equation" must be compensated for by adjustments in the other.

So, after a glide path has been selected, the means of staying on it and maintaining your targeted airspeed can only be achieved by adjusting pitch and power together.

Experienced pilots know the power settings and airspeeds for different landing weights, drag configurations and rates-of-descent for their airplanes.

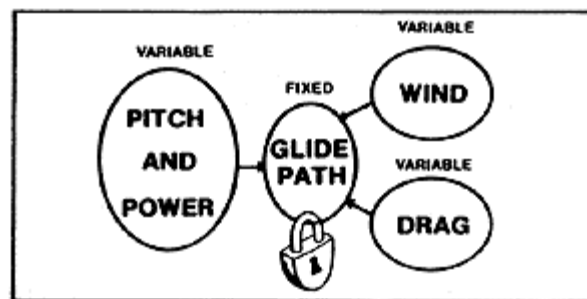

Then, these pilots need only make minor adjustments to pitch and power to maintain the selected glide path and airspeed.

The important (if not basic) point is never let your airspeed decay below the targeted airspeed for each segment of the approach and never let the airplane sink below its selected glide path.

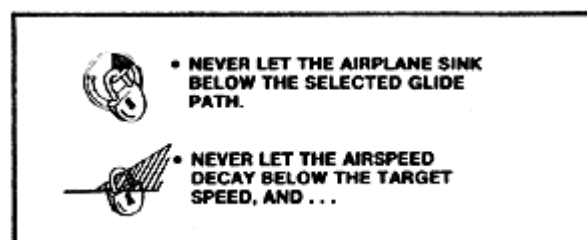

In any event, never let yourself get behind the power curve while on long final!

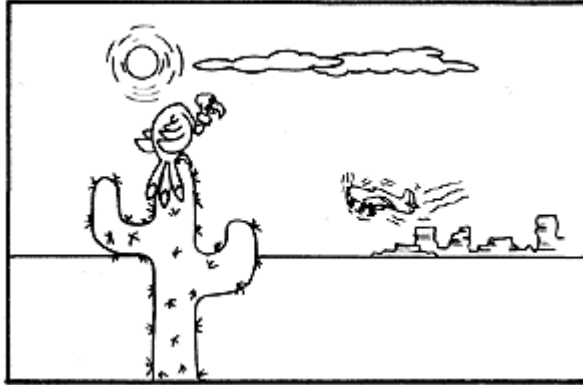

One final point: full flaps should be used for all normal landings unless the manufacturer suggests otherwise. And, once flaps have been extended, they should not be retracted. That's why it is always good practice not to go to the final flap setting until your landing is assured.

Accident Prevention Program

On Landings, Part I (Continued)

The Stabilized IFR Approach

The same basic concepts apply to the IFR approach. First, transition the airplane to the approach configuration, that is, slow the airplane and retrim it. Do this well before you intercept the glide slope, unless traffic flow requires otherwise.

Some pilots extend their landing gear to help them slow down, then add flaps after the airspeed drops into the flap operating range. If the gear has not already been used for speed control, extend the gear as you intercept the glide slope or reach the final approach fix. Additional power may be necessary with the gear and flaps extended. Be sure to retrim for each configuration change.

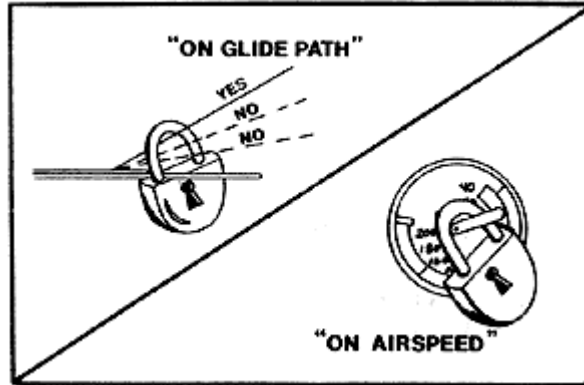

You should now be able to hold the selected airspeed and set up a stabilized rate-of-descent. With the runway in sight, and a landing assured, extend final landing flaps. Retrim again and maintain positive control of the aircraft, since adding flaps without promptly retrimming could possibly cause you to "balloon" back into the clouds.

A RULE-OF-THUMB TO CALCULATE RATE-OF-DESCENT

One Technique

<u>Glide Scope</u>	<u>Factor x ground speed (knots)</u>	=	<u>Your approx. rate-of-descent (feet/minute)</u>
3 degrees	5 x _____	=	_____
4.5 degrees	8 x _____	=	_____
6 degrees	10 x _____	=	_____

Example:

$$3 \text{ degrees} \quad 5 \times 90 \text{ knots} \quad = \quad 450 \text{ feet per minute}$$

(Chart value ... 480 feet per minute)

$$4.5 \text{ degrees} \quad 8 \times 90 \text{ knots} \quad = \quad 720 \text{ feet per minute}$$

(Chart value ... 715 feet per minute)

Another Technique:

$$\frac{\text{Ground speed (in knots)} + \text{"add a zero"}}{2} = \text{Your approx. rate-of-descent for a 3 degree glide slope only.}$$

Example:

$$\frac{90 + \text{"0"}}{2} = \frac{900}{2} = 450 \text{ feet per minute}$$

(Chart value ... 480 feet per minute)

RATE OF DESCENT TABLE

This table has been adopted (for training purposes) from a similar table published in the United States Government Instrument Approach Procedure Charts, National Ocean Survey, U.S. Department of Commerce.

INSTRUMENT APPROACH PROCEDURE CHARTS RATE OF DESCENT TABLE (ft. per min.)											
A rate of descent table is provided for use in planning and executing precision descents under known or approximate ground speed conditions. It will be especially useful for approaches when the localizer only is used for course guidance. A best speed, power, attitude combination can be programmed which will result in a stable glide rate and attitude favorable for executing a landing if minimums exist upon breakout. Care should always be exercised so that the minimum descent altitude and missed approach point are not exceeded.											
ANGLE OF DESCENT (degrees and tenths)	GROUND SPEED (knots)										
	30	45	60	75	90	105	120	135	150	165	180
2.0	105	160	210	265	320	370	425	475	530	585	635
2.5	130	200	265	330	395	465	530	595	665	730	795
3.0	160	240	320	395	480	555	635	715	795	875	955
3.5	185	280	370	465	555	650	740	835	925	1020	1110
4.0	210	315	425	530	635	740	845	955	1060	1165	1270
4.5	240	355	475	595	715	835	955	1075	1190	1310	1430
5.0	265	395	530	660	795	925	1060	1190	1325	1455	1590
5.5	290	435	580	730	875	1020	1165	1310	1455	1600	1745
		475	635	795	955				1300	1590	1745
			690	840						1720	1890

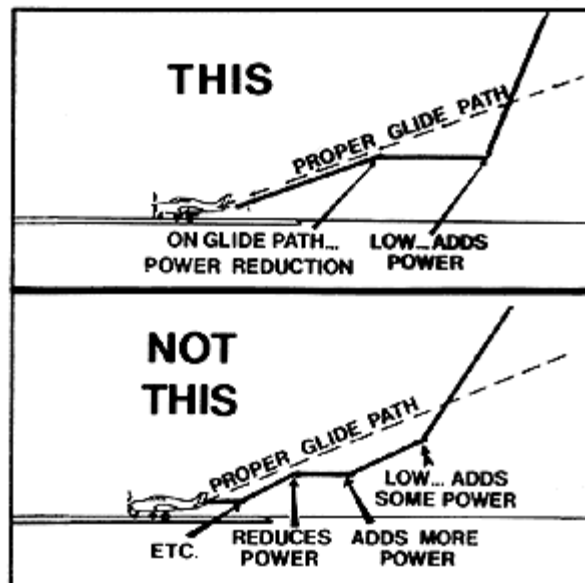

What if Things go Wrong on the Approach?

You should be interested to know that accidents involving undershoots are usually much more serious than landing long. Obviously, the energy levels involved in undershoot accidents are much higher.

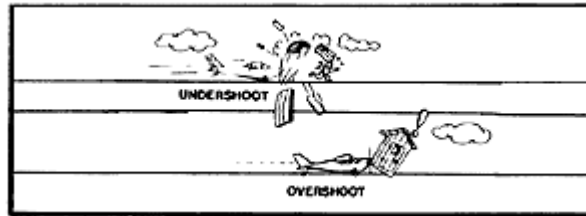

If ever you're in doubt about making the runway, add enough power to assure a safe landing. And, of course, be sure that power will be available by using your checklist for all pre-landing items! A significant number of landing accidents are caused by loss of power, and many of them are related to some basic step the pilot simply forgot.

What's the Cause of Most Undershoots?

Often the pilot is unconsciously trying to hold altitude or make the runway using elevator alone.

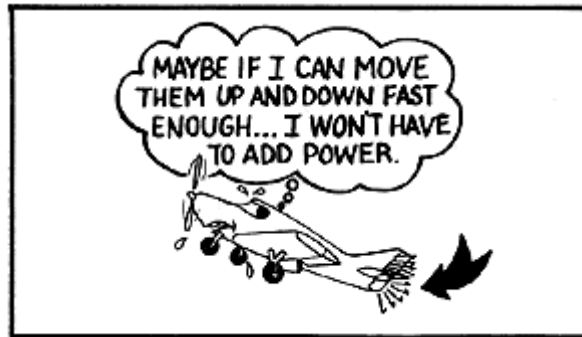

This sets up a mush or stall, resulting in an undershoot accident, or a hard landing on the runway itself.

A perfect way to sucker yourself into this is to shoot a long, low approach - especially in unstable air or in high density altitude conditions.



What can happen is that you can wind up behind the power curve with the throttle wide open and no more power available to stop the sink rate.

In this case the only thing you can do to save the situation (tough as it is) is to ease the nose over and regain airspeed and climb capability-if you've got the altitude, distance, and lack of obstacles ahead to do it. This only reemphasizes the importance of using the proper combination of power and pitch throughout the landing approach.



Undershooting-The Key Points

- Know and use the appropriate approach speeds;
- Never allow yourself to get below your targeted approach speed for each segment of the approach;
- Fly the proper glide path;
- Add power anytime you think you're too low or slow; and
- Remember the inter-relationship between pitch and power.

THE AIM POINT

The aim point is something we've all heard about but may not have been using. But it's a great aid in making good, safe landings. The aim point is your imaginary bulls-eye on the runway. It can be between two particular runway lights, or wherever.

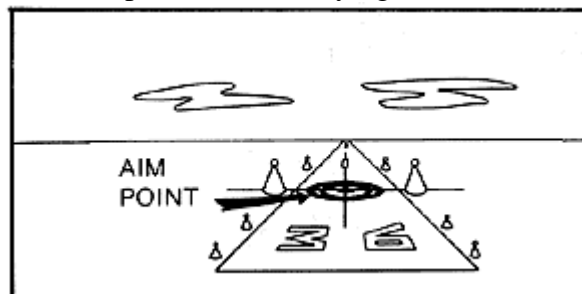

It's the reference point at the end of your selected glide path, not the actual touchdown point.

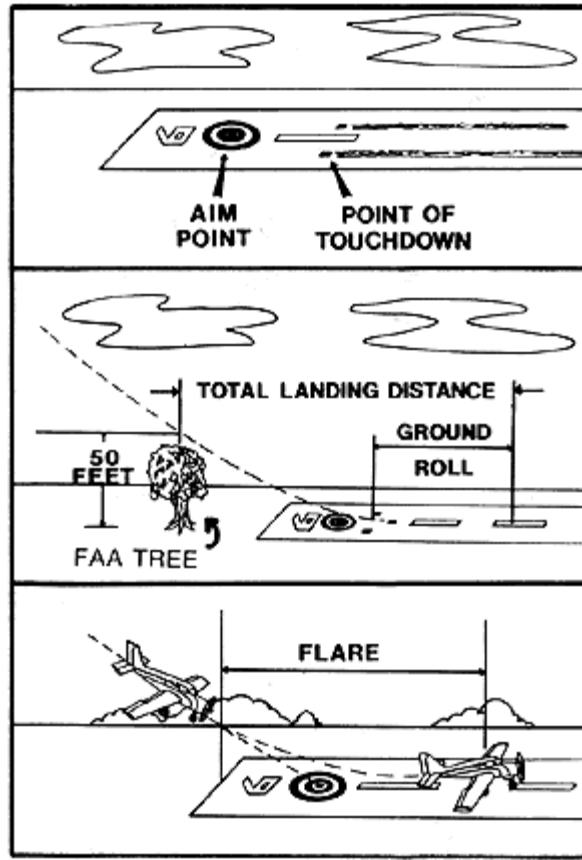

If your aim point appears to be moving toward you when you're established on final, you know that your airplane will overshoot that point.

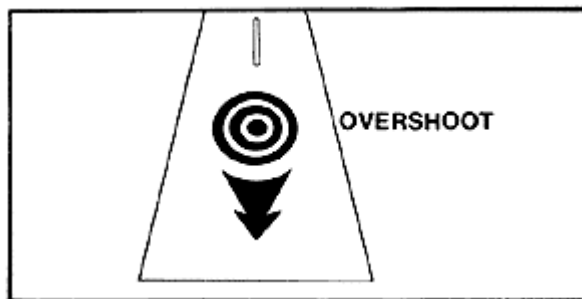

A constant position of the aim point in your windshield means things are "right on."

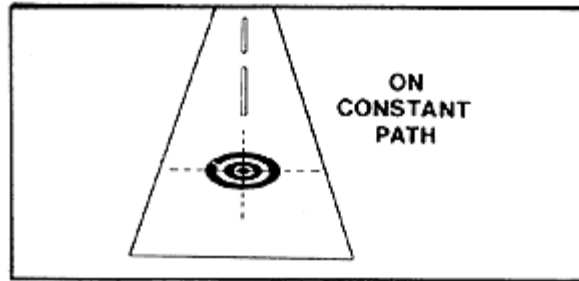

If the aim point appears to be moving away from you it's a sure sign of an undershoot.

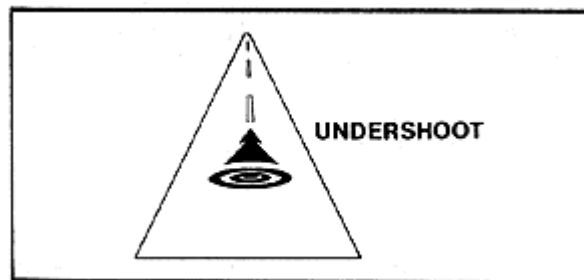

GLIDE PATH SELECTION

Once you've selected your aim point, you must also select the right glide path. Without a Visual Approach Slope Indicator (VASI) or Instrument Landing System (ILS), this becomes a personal decision.

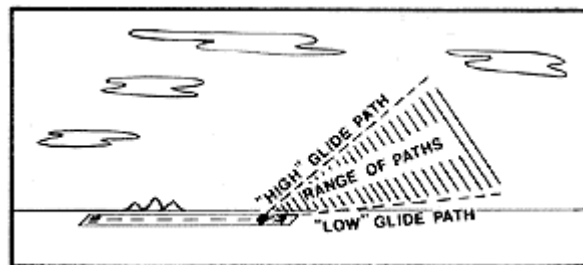

Select a glide path that works best for a particular situation, but make sure it allows for clearance of all obstacles and for a safe rate-of-descent.

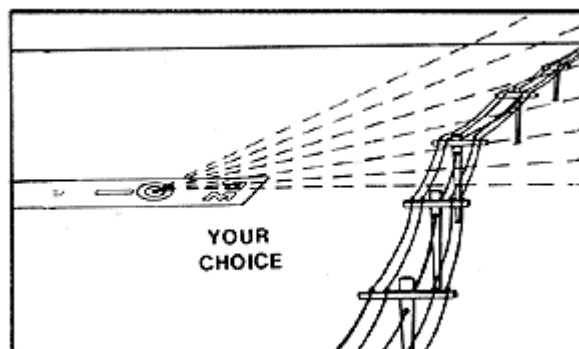

A VASI is a good aid to help establish a safe glide path. Remember, though, that while all VASIs will keep you clear of obstacles, approach angles vary. And some "complex" VASIs provide multiple approach angles to assist everything up to jumbo jets, while many smaller airports may have only non-standard VASI systems. One such non-standard system is nothing more than three plywood (or plastic) panels to be aligned by adjusting your glide path on approach.

The *Airman's Information Manual* provides a detailed description of how standard and non-standard VASIs work. Additionally, the *Airport Facility Directory* provides VASI glide angle information for standard VASIs for each runway where they are installed.

In Canada, comparable references are the *Aeronautical Information Publication-Canada (AIP-Canada)* and the *Canada Flight Supplement*.

WIND AND TURBULENCE CAN AFFECT THE GLIDE PATH

On final, your glide path can be affected by wind, wind shear, microbursts and other turbulence, including wake turbulence.

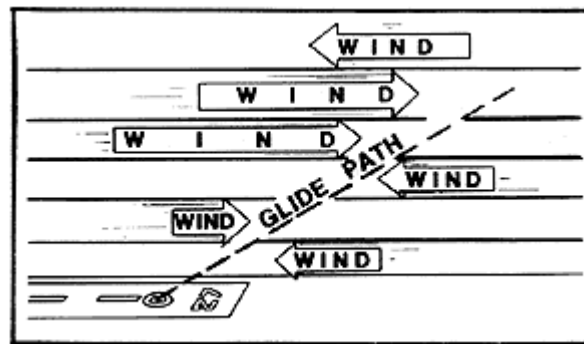

Wind shear is a major variation in wind speed and direction between horizontal layers of air.

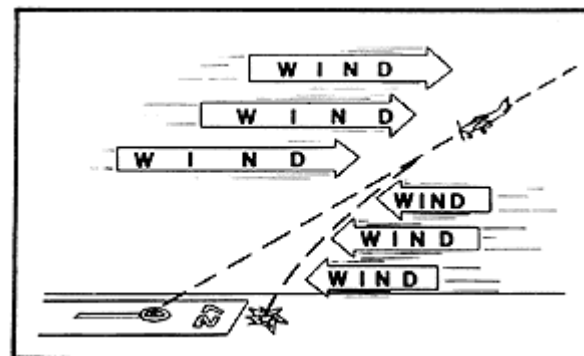

Microbursts are sharp, very strong downdrafts, associated with thunderstorms. Impossible to out-manuever and usually invisible to the eye, they are good reasons to avoid a landing at any airport with a thunderstorm nearby.

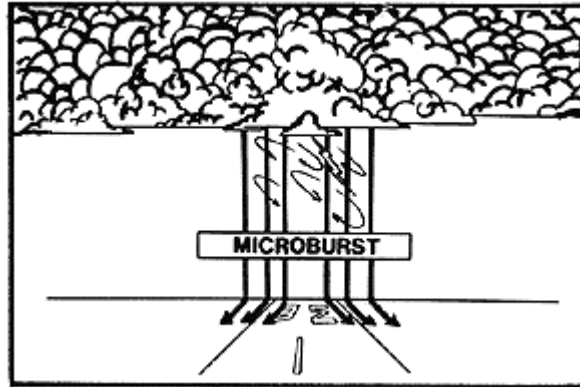

Turbulence also results from airflow over nearby mountains and winds disrupted by nearby woods, hangars or other airport structures.

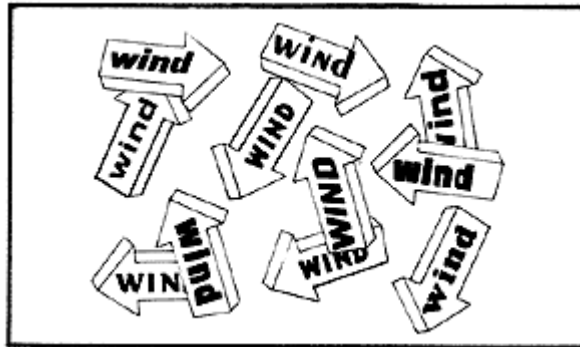

Always be ready for turbulence and its effect on your approach. When you find it, especially on short final, be prepared to add power and go-around if necessary. The sooner you add power, the less likely you are to wind up between a rock and a hard place.

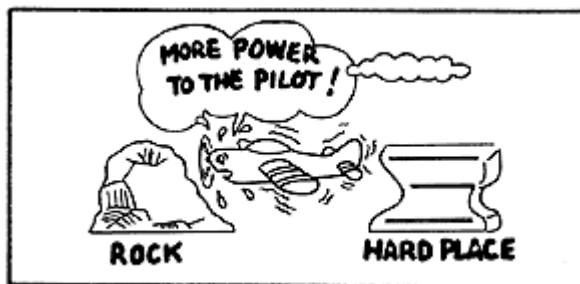

Whenever you operate at an airport served by large aircraft, be alert for wake turbulence. Study the wake turbulence avoidance procedures from time to time. They, too, are published in the *Airman's Information Manual*, the *AIP-Canada*, and in other publications.

Accident Prevention Program

On Landings, Part I (Continued)

THE CROSS-CONTROL STALL

Stalls are a frequent cause of landing accidents and the deadliest of all is the cross-control stall.

A cross-control stall is usually set up on base and the potential for it becomes greater in the presence of a tailwind on that leg. A tailwind creates greater groundspeed which gives you less time to react.

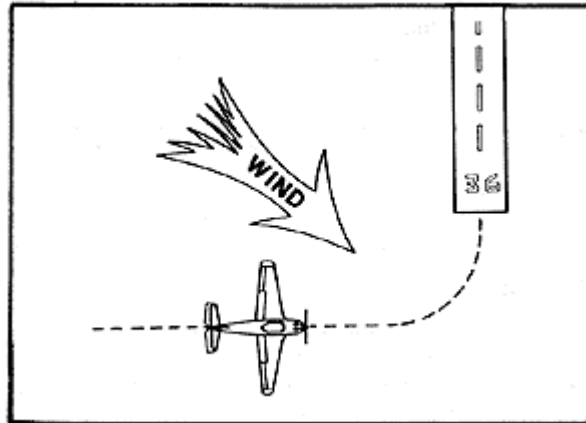

Add a distraction such as conflicting traffic or a problem in the cockpit and you're ripe for a late turn onto final and the potential for a cross-control stall.

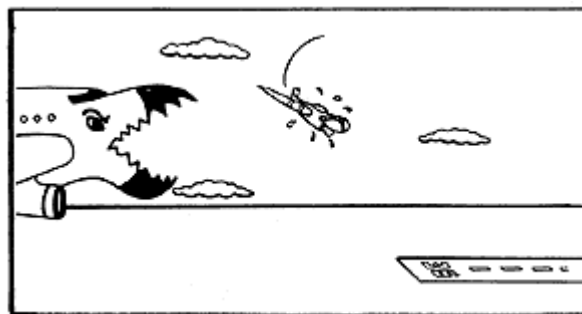

Making that turn to final, you don't want to make a steep banked turn because you know that the stall speed increases with bank angle.

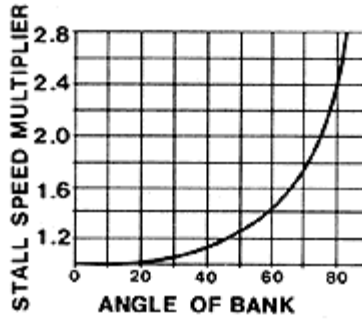

Instead, you try to increase the rate-of-turn with rudder alone, all the while keeping your bank shallow with opposite aileron.

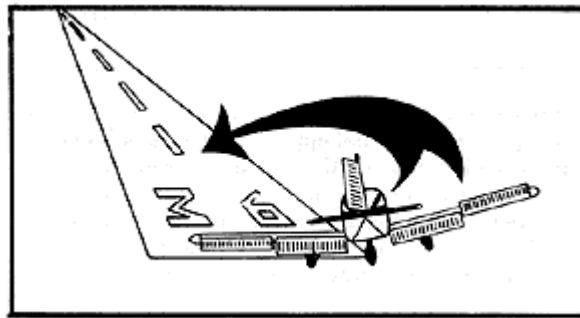

Of course, now you'll need more "up" elevator because the combination of inside rudder and "down" aileron drag makes the nose drop.

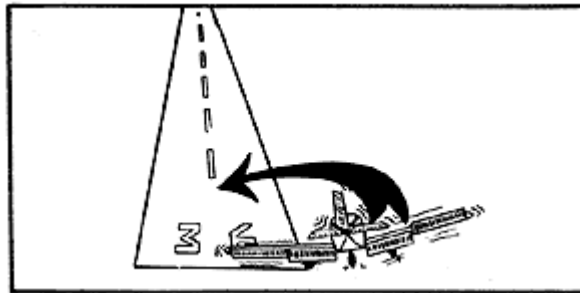

As you pull back, you slow down and, bang, there's a stall and a snap roll toward the lower, inside, wing.

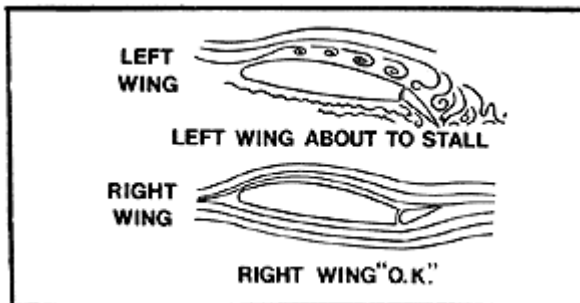

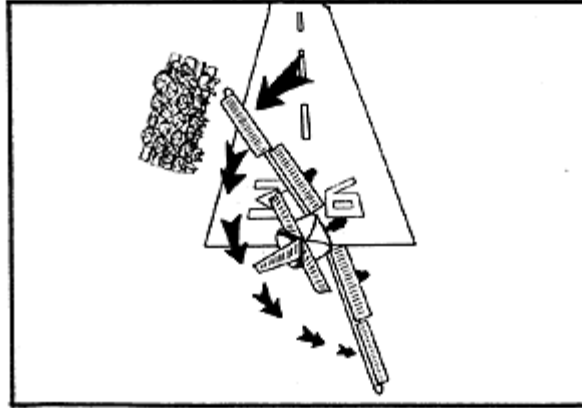

This situation can be avoided by good planning, including a properly flown pattern, proper airspeeds, and a timely go-around when things don't feel right.

Some other points:

- Complete as much of your "before landing" check-list as possible before entering the pattern.
- Look outside the cockpit for helpful indications of wind-flags, smoke, and ponds, for example.
- Listen to the radio for UNICOM and ATIS advisories on landing conditions.
- When you have the option, handle a direct cross-wind situation by flying a pattern that gives you a headwind, not a tailwind, on base.

HARD LANDINGS, BOUNCED LANDINGS & LOSS OF DIRECTIONAL CONTROL

Let's now look at three other types of landing phase accidents: the hard landing, the bounced landing, and loss of directional control on roll-out. These are not killer mishaps like the cross-control stall and the undershoot, but they, too, result in substantial damage, injuries and embarrassment.

Hard Landings

Drop-in or "hard" landings cause a great deal of monetary damage to airplanes each year. These accidents result from several causes:

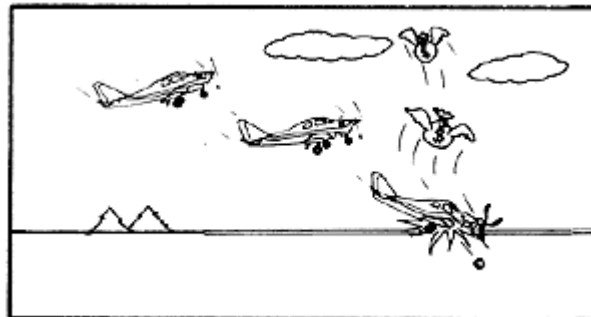

You can set yourself up for a hard landing by not looking out ahead of the airplane and losing your perspective relative to the ground.

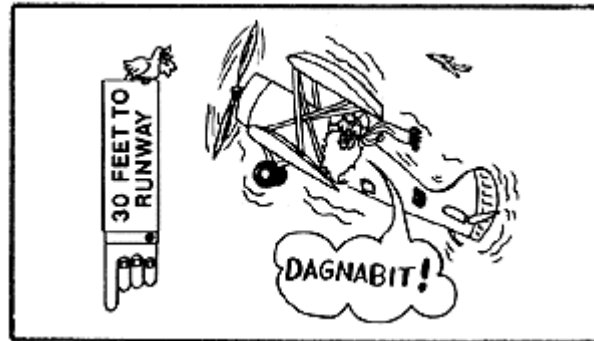

Loss of perspective can also be the result of improper scanning during flare and touchdown.

Remember to look outside the cockpit-way outside. And don't forget to use your peripheral vision as well. It's something you learned way back in pre-solo: to focus your attention ahead of the airplane.

Hard landings are also the result of distractions.

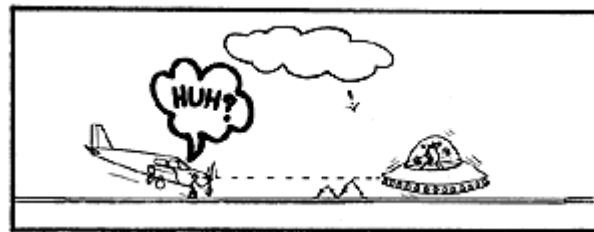

A typical distraction is a disturbance with passengers in the cabin. Don't be distracted! The landing is the last part of the flight, the part where you're the most tired, yet it's the point where the most concentration is required.

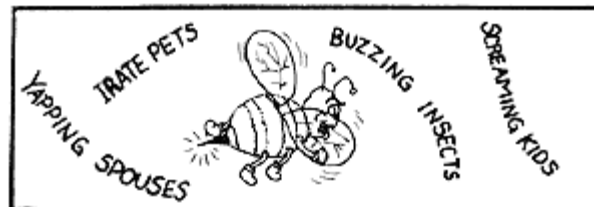

To alleviate distractions, airlines have adopted the "sterile cockpit" concept. Below a certain altitude, all conversation is limited only to matters concerning aircraft operations. It's a rule you may want to adopt.

Ballooning is another cause of hard landings.

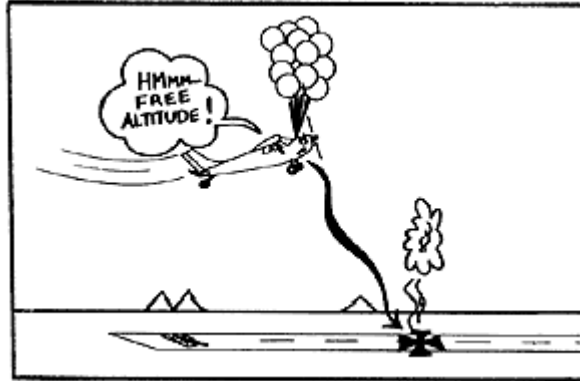

This often results from excess airspeed combined with poor flare technique. (Yanking back on the controls before touchdown can put you several stories above the runway with airspeed decaying rapidly.)

If this happens, ease the nose over gently and add power if necessary.

Remember, too, a full power go-around may be your best bet to avoid a hard landing after ballooning.

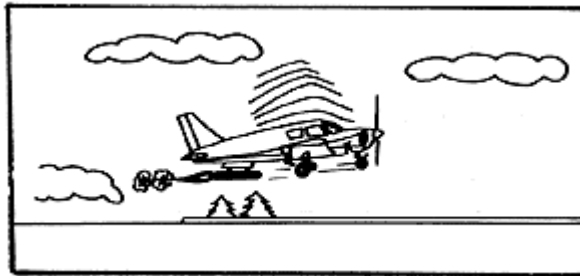

Another cause of hard landings, as discussed earlier, is trying to stretch a final approach by raising the nose without adding power. Also beware of running out of elevator control during flare. A typical example happens when you're too slow with too much weight up front. You may not have the flare power you need. A high descent rate makes these conditions even more serious. Be sure you're OK on CG.

In summary, if you think you're headed for a hard landing:

- Add power to arrest the sink rate;
- Keep your wings level;
- If you decide to make a go-around, make the decision sooner rather than later.

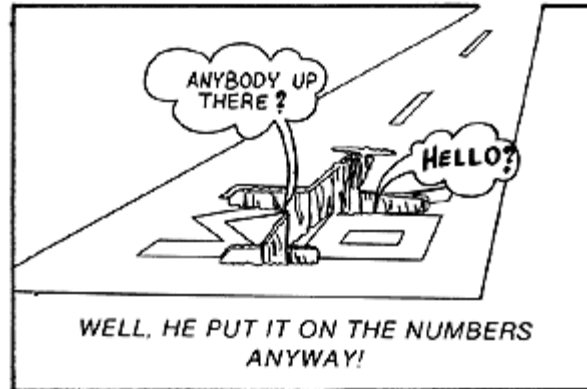

The Bounced Landing

The bounced landing, or pilot-induced oscillation (porpoising), was supposed to be cured by the introduction of tricycle landing gear. Not so. Innovative pilots keep discovering new ways to make bad landings.

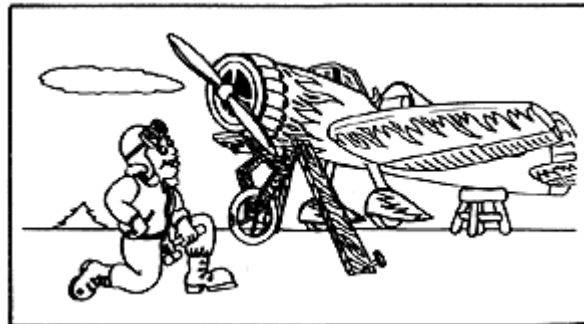

In a bounced landing, the airplane comes in nose-wheel first (or for a tail-dragger, main gear first) setting off a series of motions that imitate the jumps and dives of a porpoise—hence the name.

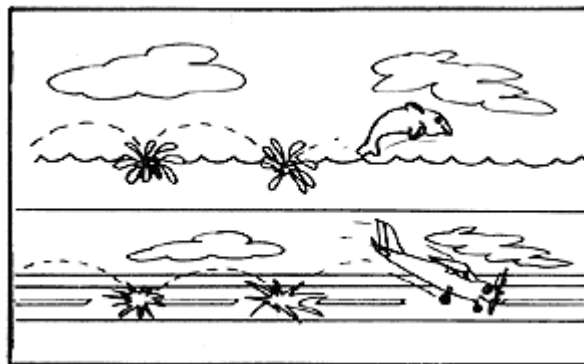

The problem is improper aircraft attitude at touchdown, sometimes caused by inattention, by not knowing where the ground is, by mistrimming, or by trying to force the aircraft onto the runway.

No matter what the cause, the situation must be corrected immediately.

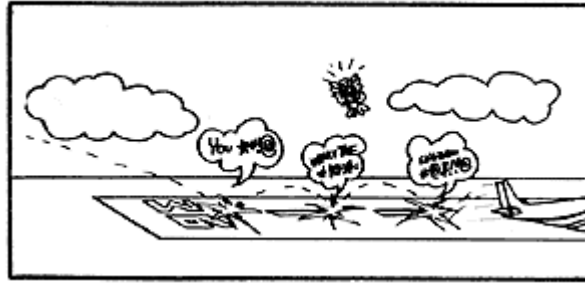

Ground effect, a factor from the surface to a height of about half the plane's wing span, decreases elevator control effectiveness and increases the effort required to raise the nose and hold the airplane off. Not enough elevator (or stabilator) trim can result in a nose-low contact with the runway and a porpoise.

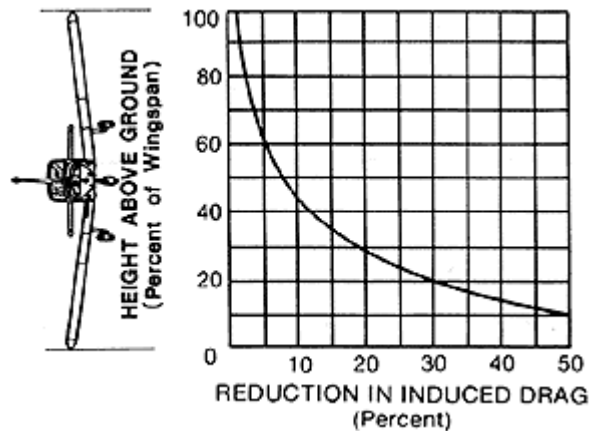

The secret to a good landing is proper aircraft attitude at touchdown. For tricycle gear planes, it's the attitude that assures that the main wheels will touch before the nose wheel. You'll need to develop a feel for this attitude in your particular aircraft and stay proficient at it. You'll also need to know what it "feels like" at all combinations of weight and CG.

Porpoising can also be caused by improper airspeed control. Usually, if an approach is too fast, the airplane floats and the pilot tries to force it on the runway when the airplane still wants to fly.

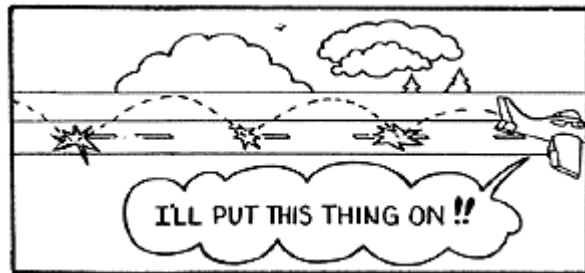

A gust of wind, a bump in the runway, even a slight tug on the wheel will send the aircraft aloft again. What to do?

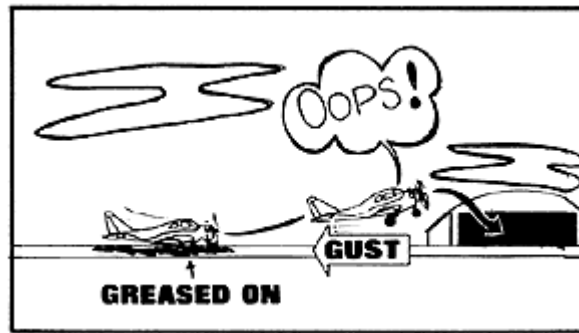

First, don't push the nose over. Ease it over and reland, this time holding the proper pitch attitude until the aircraft touches down. Add back pressure continually as the aircraft slows during the flare.

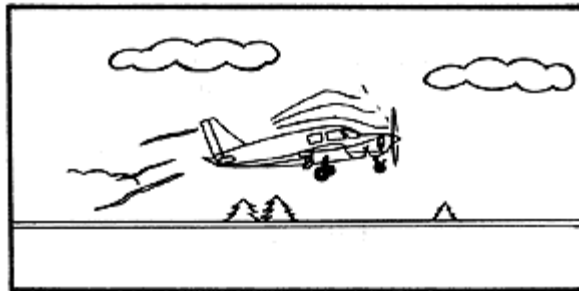

Too many airplanes have been pranged because of the pilot's desire to put the airplane on the ground. A go-around may be the answer in some cases of porpoising.

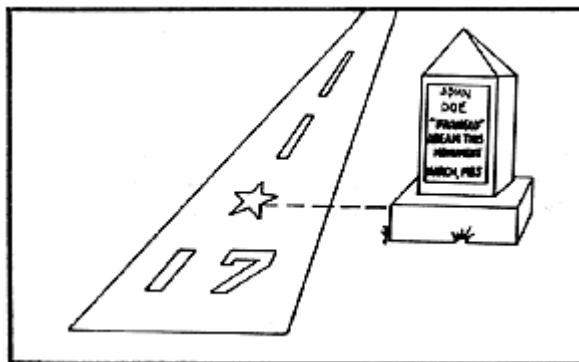

To avoid porpoising:

- Always trim the airplane for a stabilized approach;
- Avoid excess airspeed and "floating";
- Don't be distracted;
- Maintain proper pitch attitude; and

- Stay proficient.



Loss of Directional Control

Engineers also thought tricycle landing gear would eliminate directional control problems and ground looping. Not so.

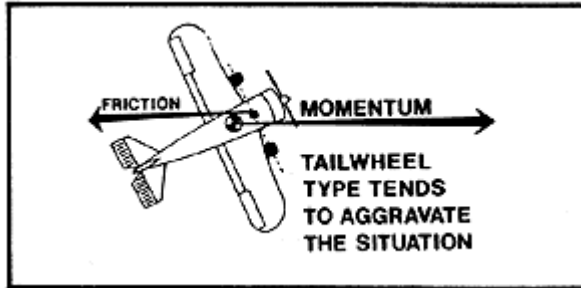

(For those who aren't familiar with this nemesis, a ground loop is an uncontrolled turn-often violent-usually on landing and roll-out.)

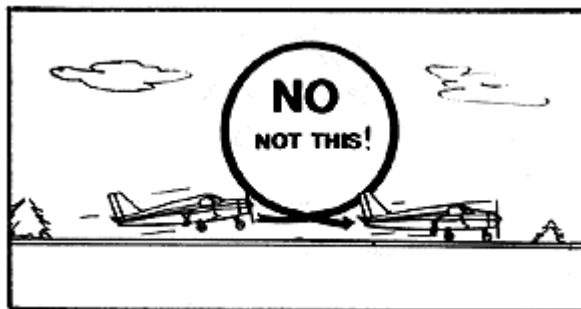

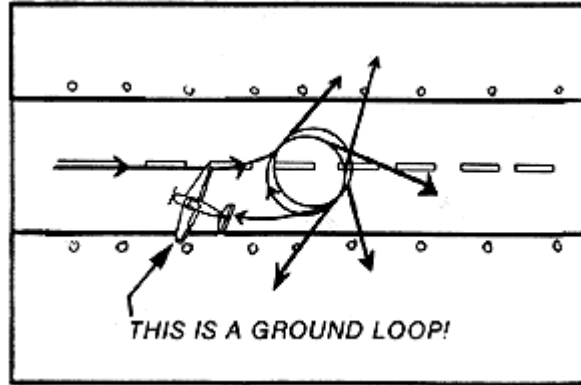

Accident Prevention Program

On Landings, Part I (Continued)

How to avoid loss of directional control? Recognize and correct problems early. Stop any incipient turn or swerve almost before it starts. Get right on it.

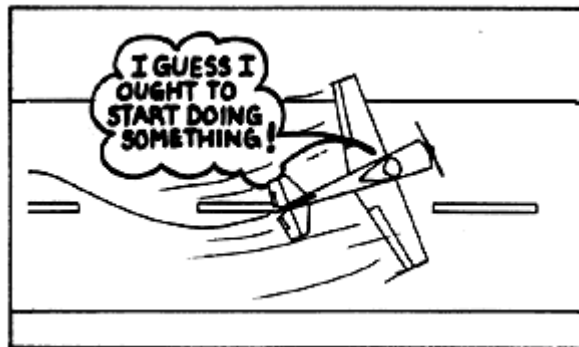

Also, use your controls to their best advantage. Keep the weight of tricycle gear aircraft on the mains with elevator back pressure-this also desensitizes the nose-wheel.

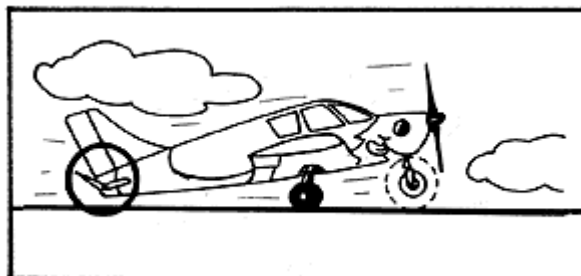

In tail-draggers, full back stick puts more weight on the tail-wheel for better directional control.

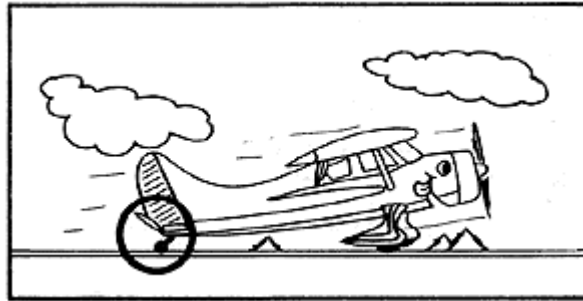

Lack of sufficient back pressure can multiply the effects of small rudder movements (or reactions to crosswinds) - overcorrections that can induce trouble.

If you get in trouble, close the throttle, apply back pressure and regain control.

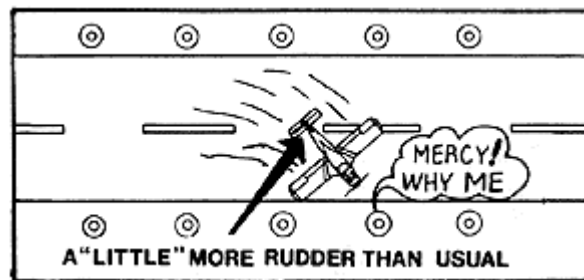

Crosswinds can be a real problem.

Remember, in a crosswind landing, the longitudinal axis of the airplane must remain parallel to the runway centerline as must the flight path of the airplane.

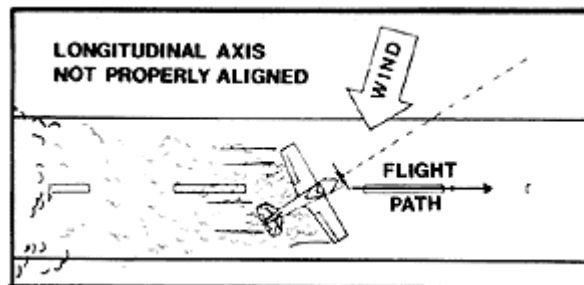

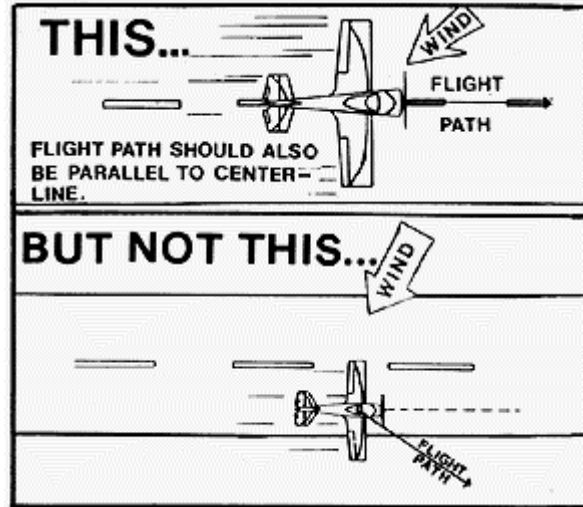

If you don't do both, strong side loads may be exerted on the landing gear, and a ground loop could occur (resulting in even higher side loads).

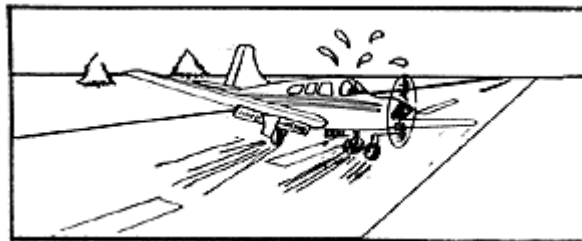

Proper crosswind technique is a must. In the case of a left crosswind, the left wing must be lowered into the wind and this control input countered with right rudder to maintain the proper track down to the runway. Again, the longitudinal axis of the airplane must be aligned with the flight path which, hopefully, is parallel to the runway centerline.

By the way, you should know the crosswind limitations of your airplane and yourself. In some cases, it is best to stay on the ground, or, if airborne, to locate another runway more aligned with the wind.

One of the worst ego bruises occurs when the pilot tries to clear the runway before he or she has slowed down enough. This is even more of a problem in some crosswind conditions.

Simply following the yellow exit line may lead to an unplanned cross-country. A much better technique is to stay on the runway centerline until you've slowed down to taxi speed.

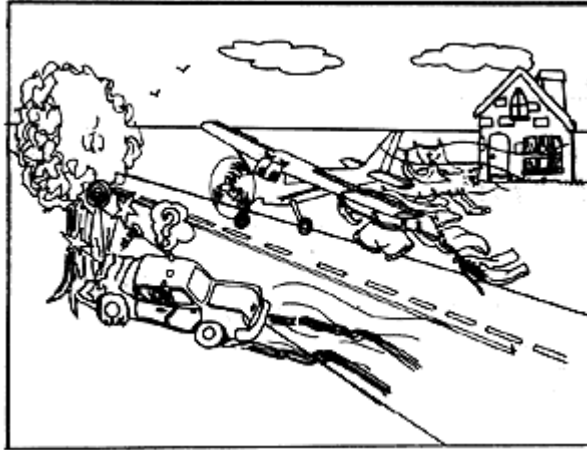

Face it, there's only one principal cause for loss of directional control-pilot error. It's not only lack of knowledge of the "basics". Recent studies also point to preoccupation, stress, fatigue, or just being on a "mental holiday."

Use the sterile cockpit rule on yourself. Think ahead of the airplane on every approach. Continue to fly the airplane after touchdown. And stay proficient.

Worst of all. don't freeze. Remember the saying on the mayonnaise jar, "keep cool but do not freeze." Stay on top of the situation.

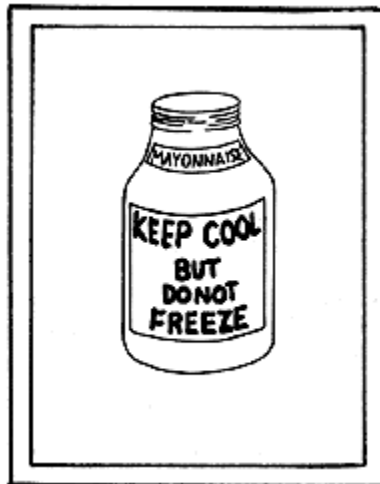

Panic can also result in a reversion to "driving response," or trying to steer the aircraft down the runway with the control wheel. That wheel has no purpose in steering on the ground and "driving response" can lead to loss of control.



To summarize, directional control accidents can be greatly reduced if, as pilots, we follow these simple rules:

- Maintain proficiency;
- Stay ahead of the airplane;
- Avoid wheelbarrowing by holding back-pressure on the controls during roll-out;
- Keep your flight path and longitudinal axis parallel to the runway centerline;
- Double check wind conditions on short final;
- Stay within the demonstrated crosswind capabilities for both you and the airplane;
- Slow the airplane down before taxiing clear;
- Keep your thoughts on the landing, that is, don't be distracted, and finally;
- "Keep cool but do not freeze."

Note: The suggestions and "rules" given in this handout are intended to be helpful aids only and are not intended to replace or supersede the recommendations of the aircraft manufacturer.